

Concrete Batching Plants



FABO[®]

Crushing Screening Plants



FABO Stationary Crushing Plants

FABO, which sells crushing, screening and washing facilities to 7 continents, produces the most powerful crushers and sieves in the market. With its low maintenance costs, innovative designs and 17 years of experience, it offers unique solutions to its customers.

Stationary crushing plants have advanced equipment that provides high efficiency for mines, quarries and construction projects. Our crusher plants with different capacities are ideal for solutions suitable for every project.

Stationary crushing plants can be used for aggregate production in various sizes, for crushing hard mines and ores. To maximize your profits and improve your business volume, like companies around the world, choose FABO crushing, screening and washing facilities.

Our stationary solutions: Stationary Stone Crushing and Screening Plants

- Vibrating Bunkers
- Jaw Crushers
- Primary Impact Crushers
- Tertiary Crushers
- Vertical Shaft Crushers
- Cone Crushers
- Vibrating Screens
- Dewatering Screen
- Spiral Washers
- Bucket Washers
- Wobbler Feeder



Cone Crushers



CC-300 Cone Crushers

Cone crushers are designed to crush hard and abrasive stream and quarry materials such as granite, basalt and andesite. Thanks to the long-lasting wear parts, the cone crusher is lasts longer.

In addition, since maintenance and repair operations can be done easily on the crusher, operating costs are also low.

The crusher is also called “cone crusher” since the crushing process is done between conical surfaces. In terms of both size and structure, many different shapes are encountered today. In general, there are two main types as “movable shaft” and “fixed shaft”.

MODEL	CC-300
FEED OPENING	241 mm
CAPACITY	300-400 TPH
MOTOR POWER	200 kW
WEIGHT	16190 kg

DIMENSION	CC-300
A	3030 mm
B	2775 mm
C	1200 mm

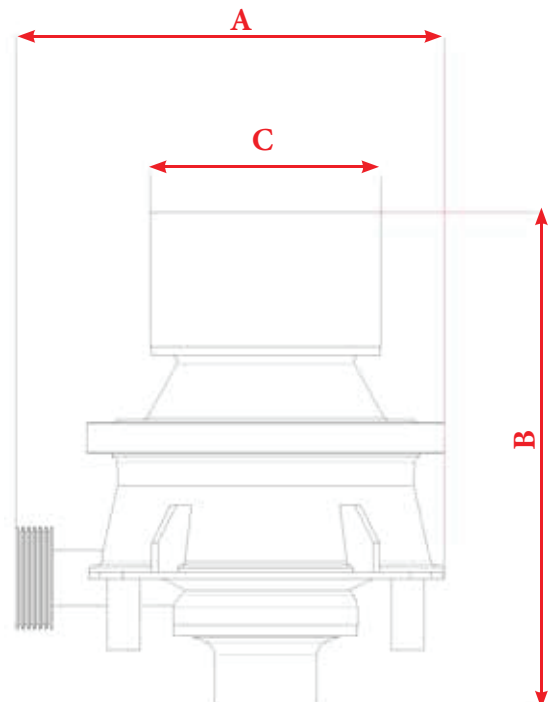

General Specifications and Futures:

- Inner design protected against dust
- Option to use automatic or manual
- Easy setting possibilities
- Easy intervention and maintenance
- Operation from the control panel, stop, lubrication, hydraulic system and inlet width control



Contact:



fabo@hidro-rad.hr



+(385) 21 721 041

